

Congestiemanagement I/II

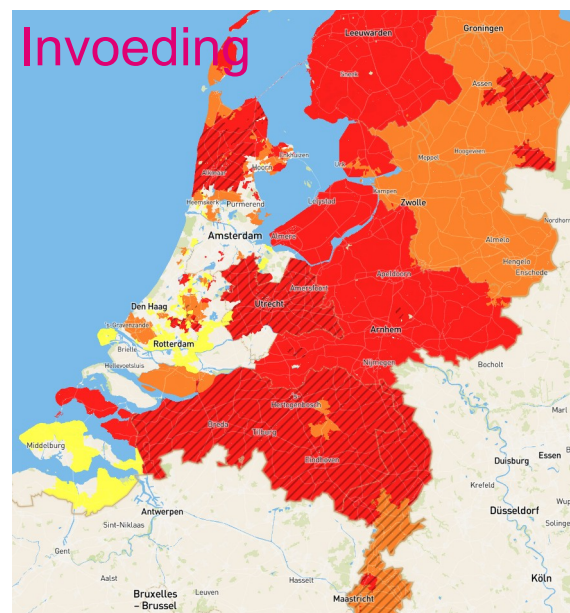

DER kast
GOPACS
 USEF
 JOUW
 ENERGIE
 MOMENT
 InterFLEX
 opweksturing
 van pilots...

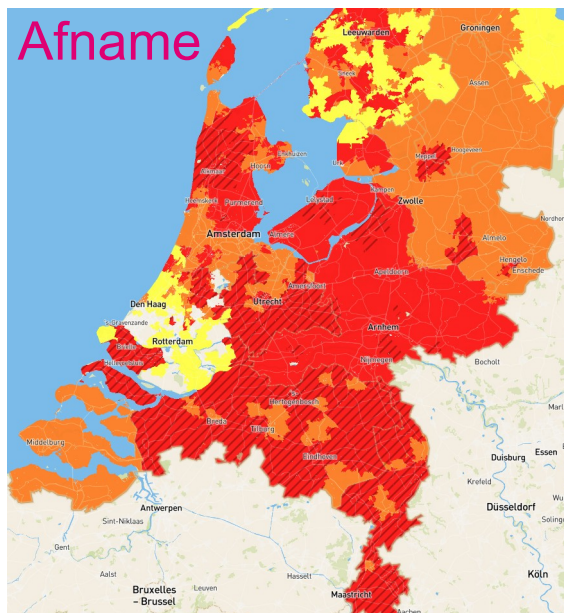

Drie congestiemanagementproducten:

1. Capaciteitsbeperkende contracten
2. Marktgebaseerd redispatch
3. Niet-marktgebaseerd redispatch

Noodmaatregel als achtervang

GOPACS



... naar productie

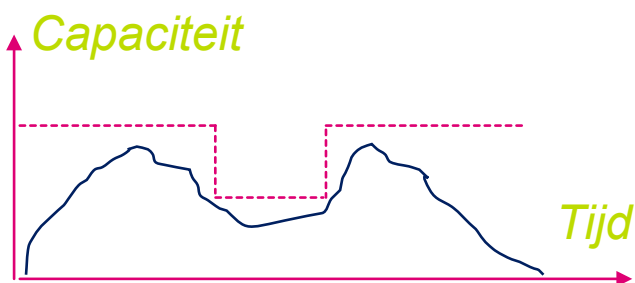

Capaciteitsbeperkende
 contracten

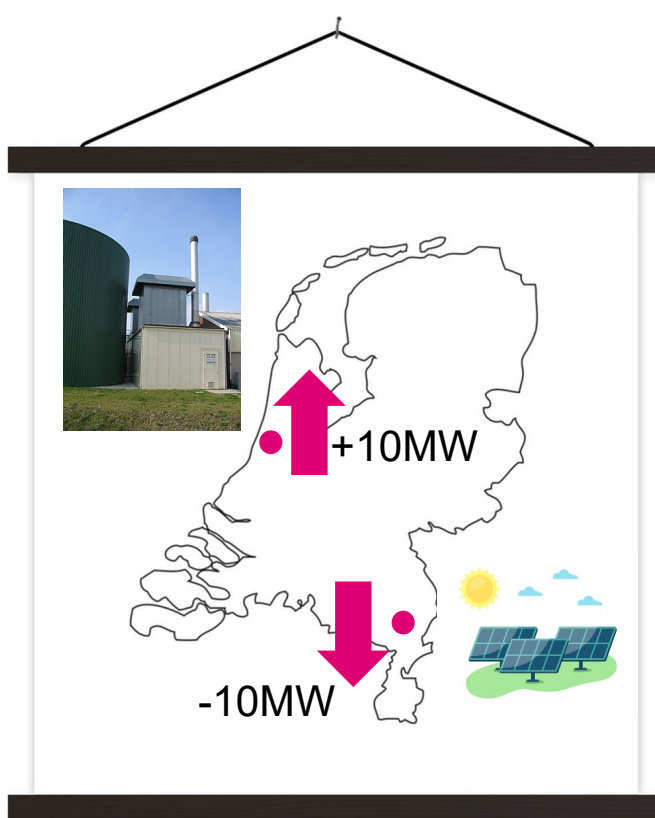

Redispatch

Afschakelen
 Noodcurtailment



day-ahead

intraday

real-time

Tijdlijn



Congestiemanagement II/II

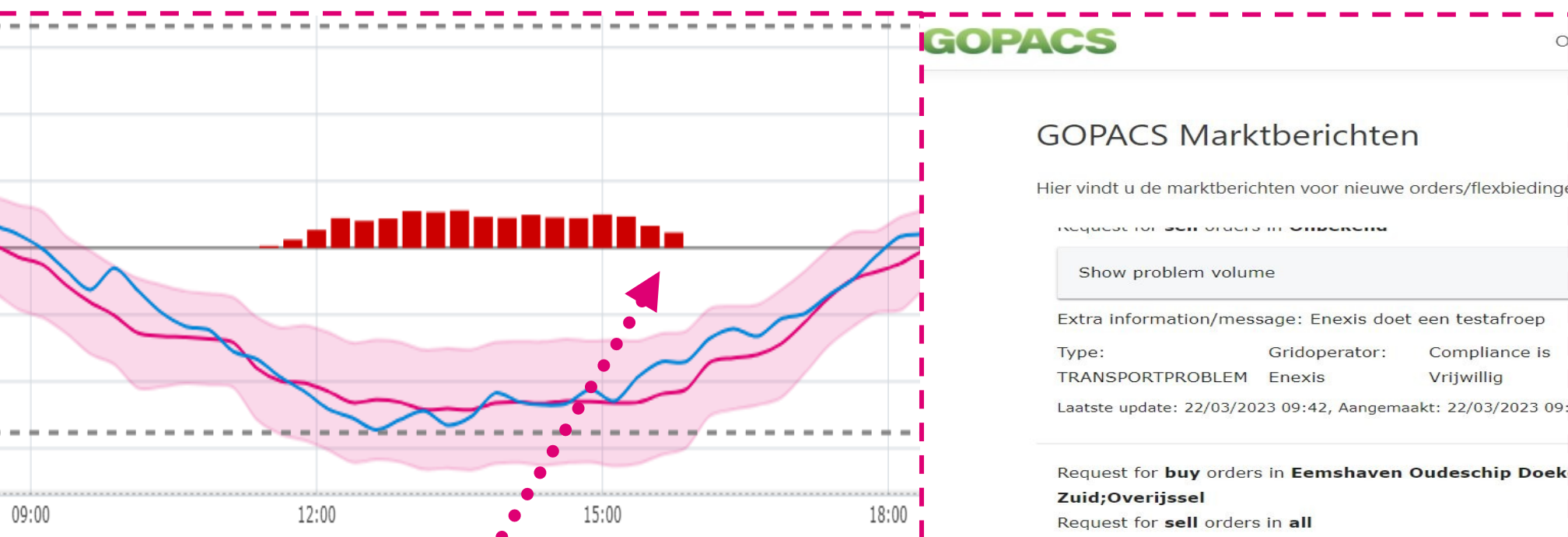
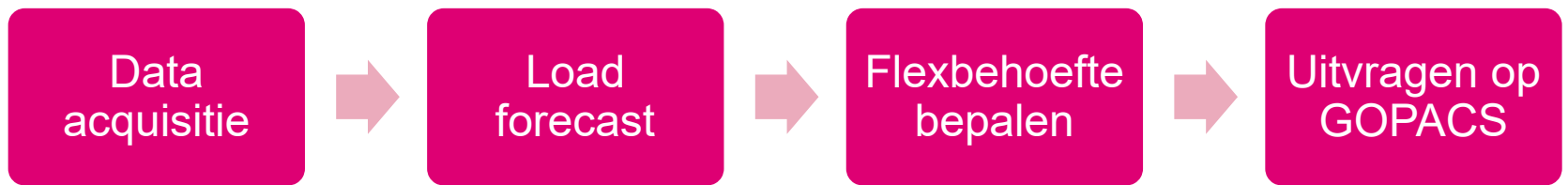

Redispatch proces

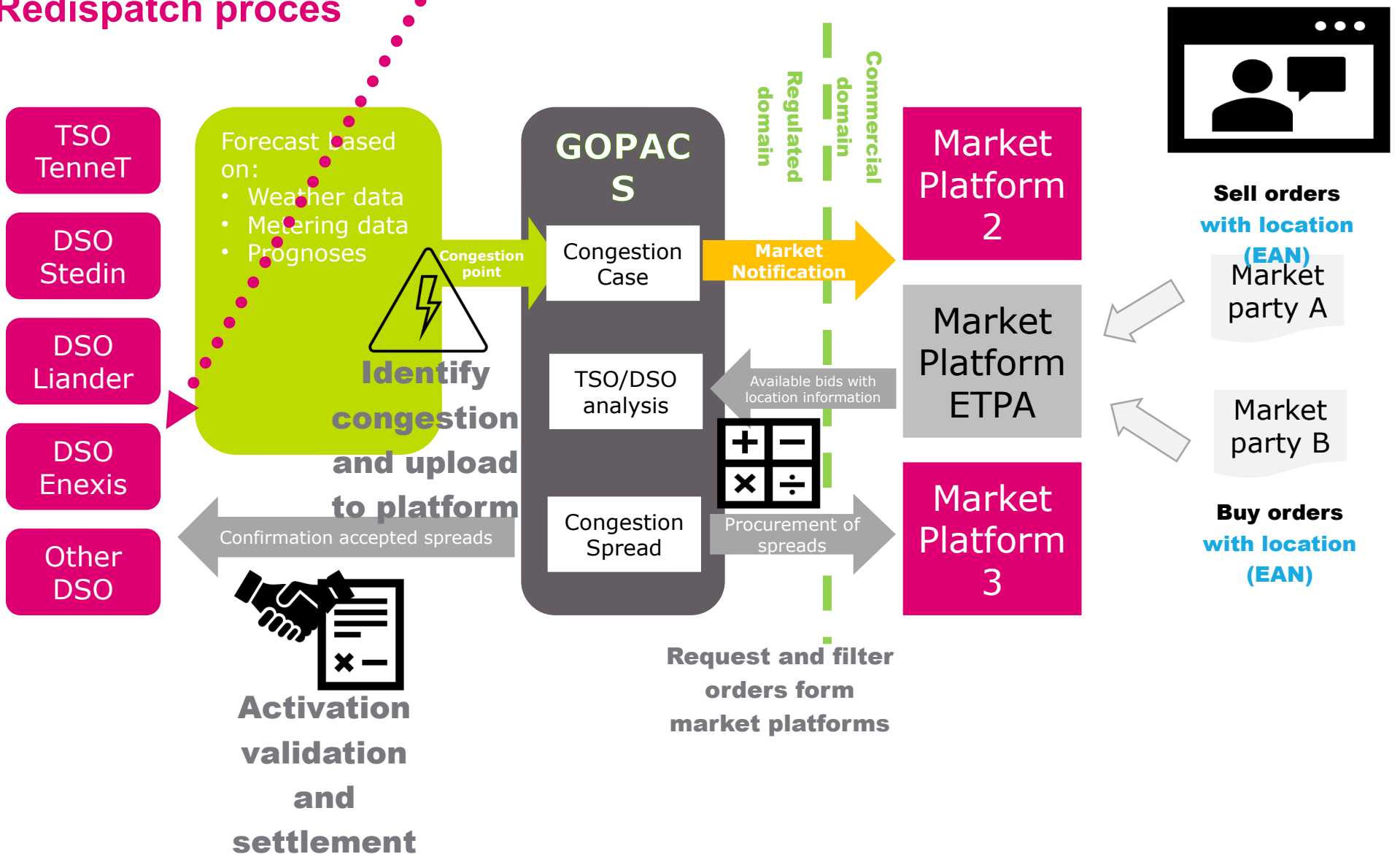



DIT IS ENEXIS

We zijn een netwerkbedrijf

Met onze infrastructuur zorgen wij ervoor dat miljoenen klanten in Groningen, Drenthe, Overijssel, Noord-Brabant en Limburg toegang hebben tot elektriciteit en gas.

| | | |
|---|---|---|
| 5.000 collega's die dag en nacht klaarstaan | 99,99% betrouwbaarheid van ons energienet | 83% groei van ons werkpakket en opzichte van 2018 |
|---|---|---|

KERNGEGEVENS ENEXIS GROEP

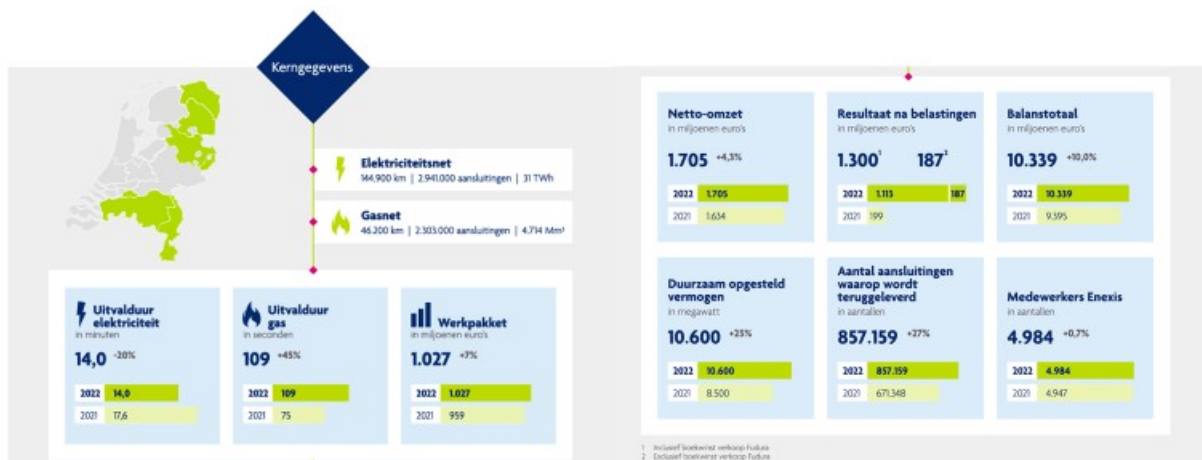

DOELEN EN KERNWAARDEN

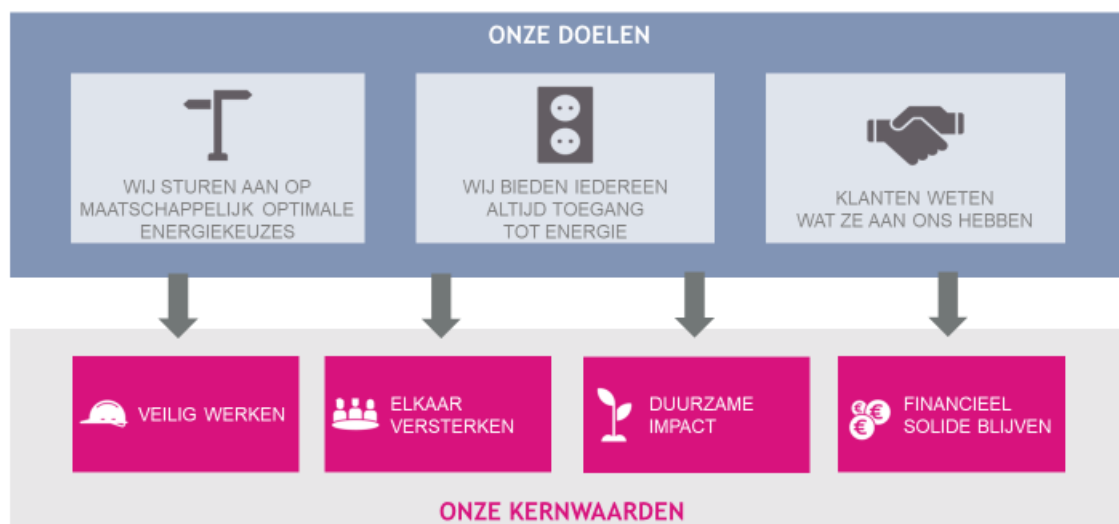



ENERGIETRANSITIE IN CIJFERS

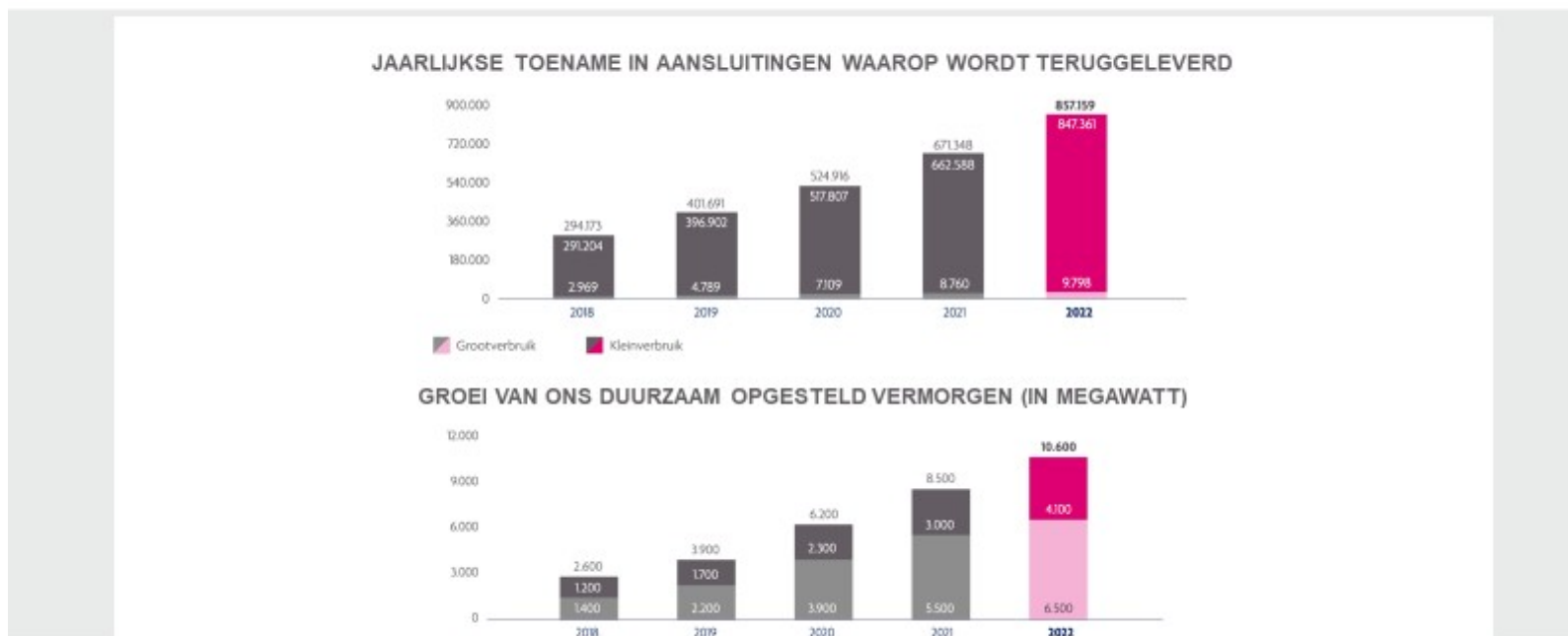

19

ENERGIETRANSITIE IN CIJFERS

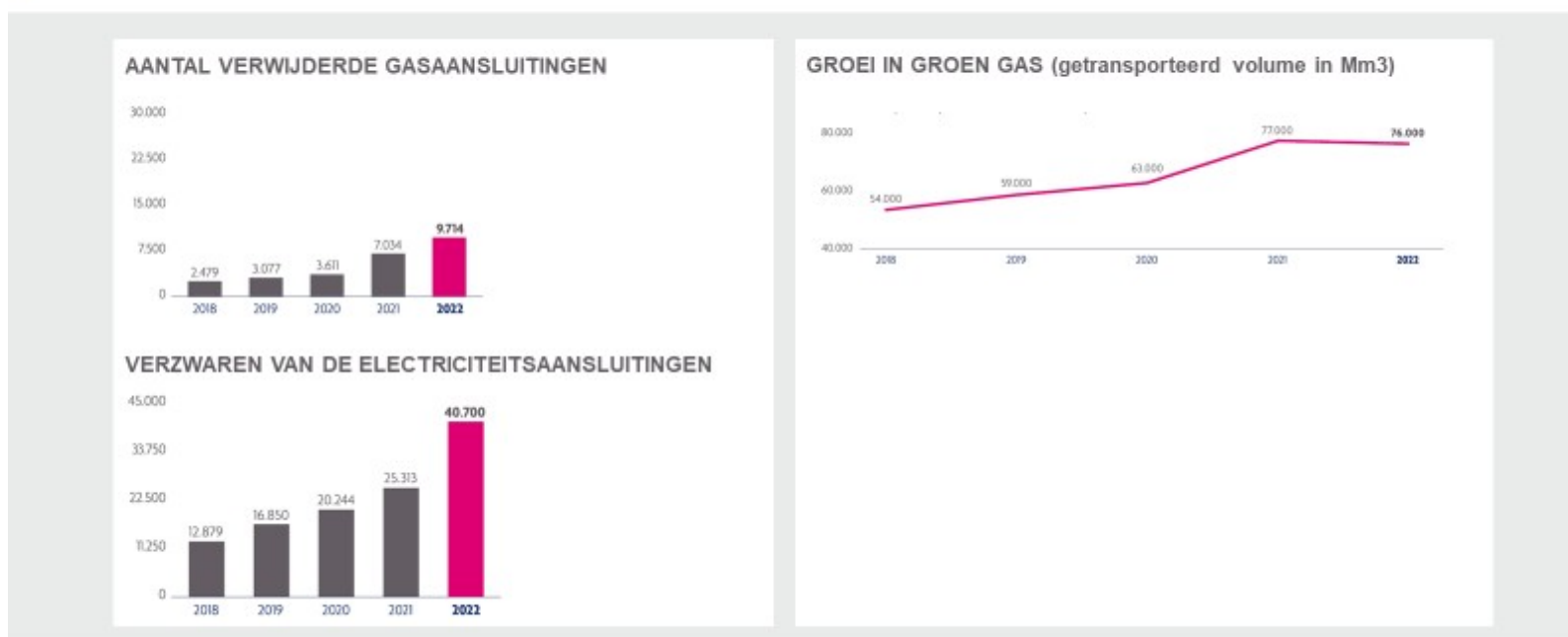

20

Project EHVO

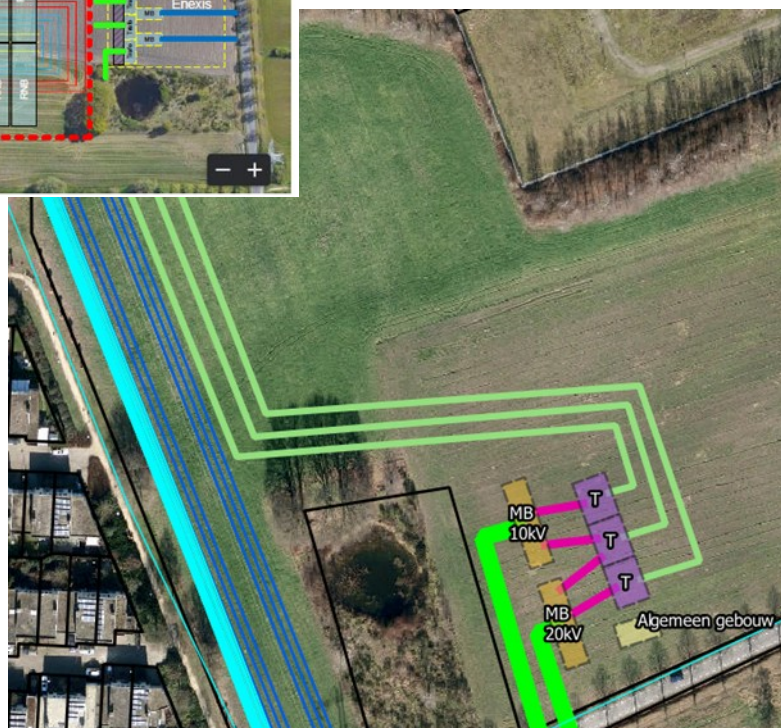
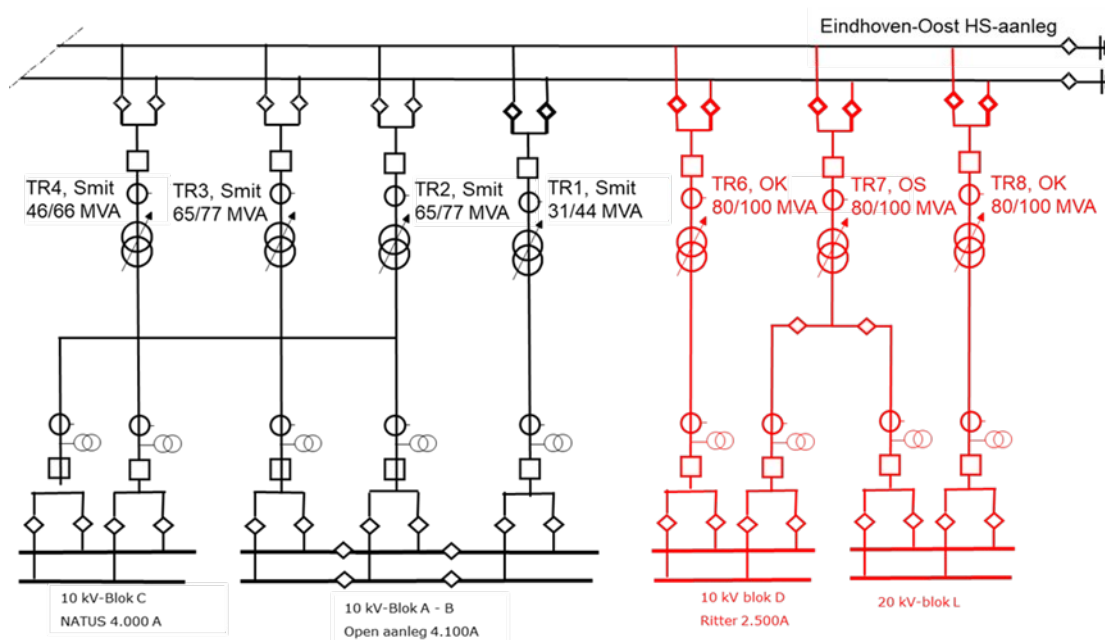

Elektriciteitsnet opbouw

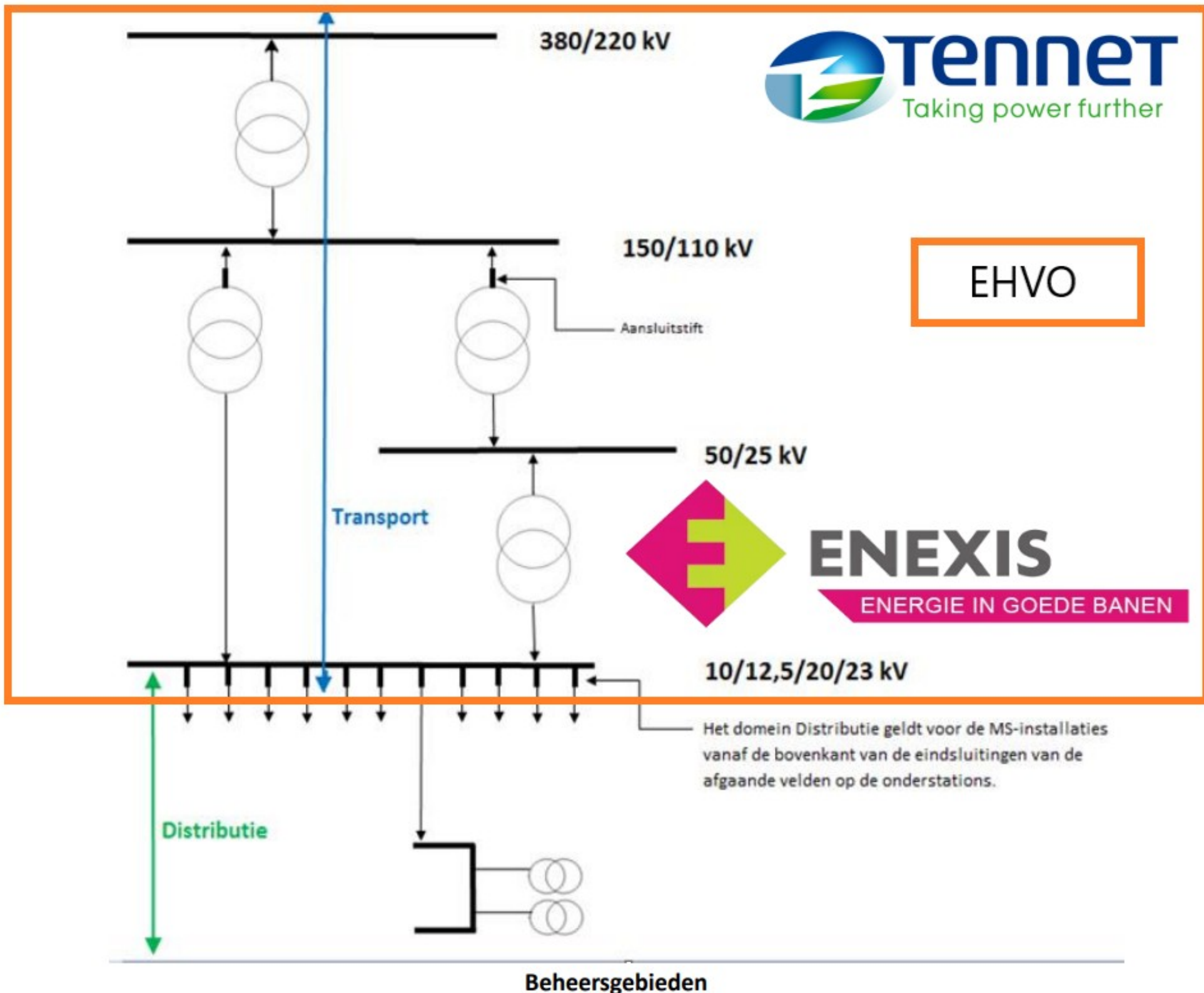



Primair



150/10-20kV transformator

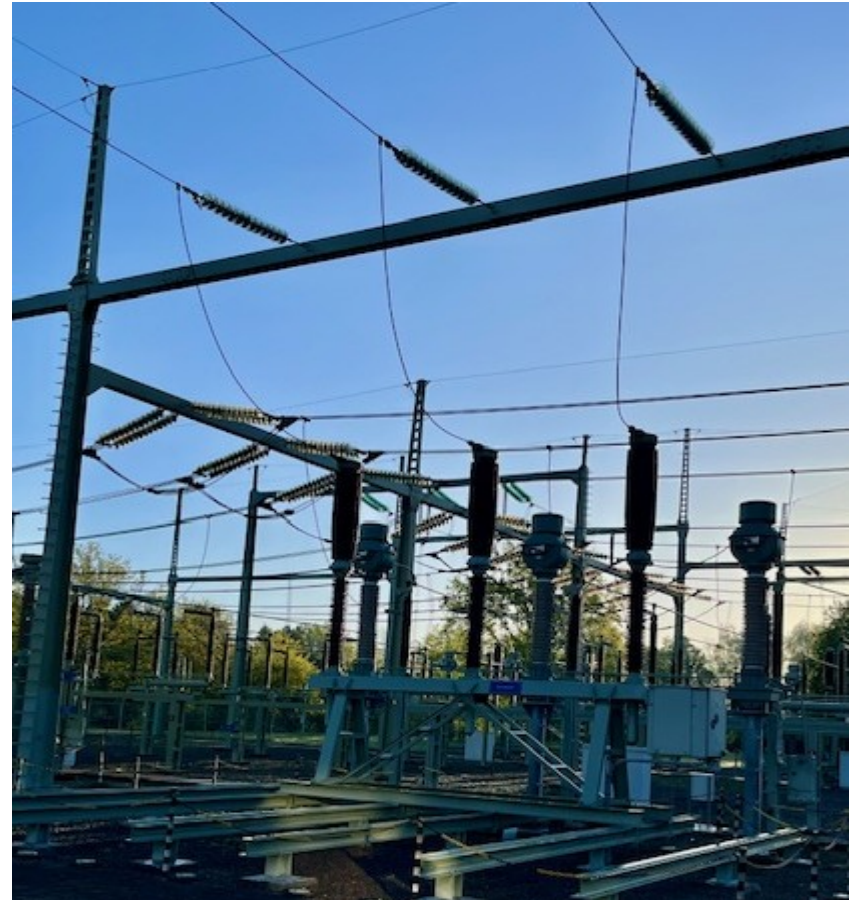

150kV veld (Tennet)



10kV Midden spanning installaties



Secundair

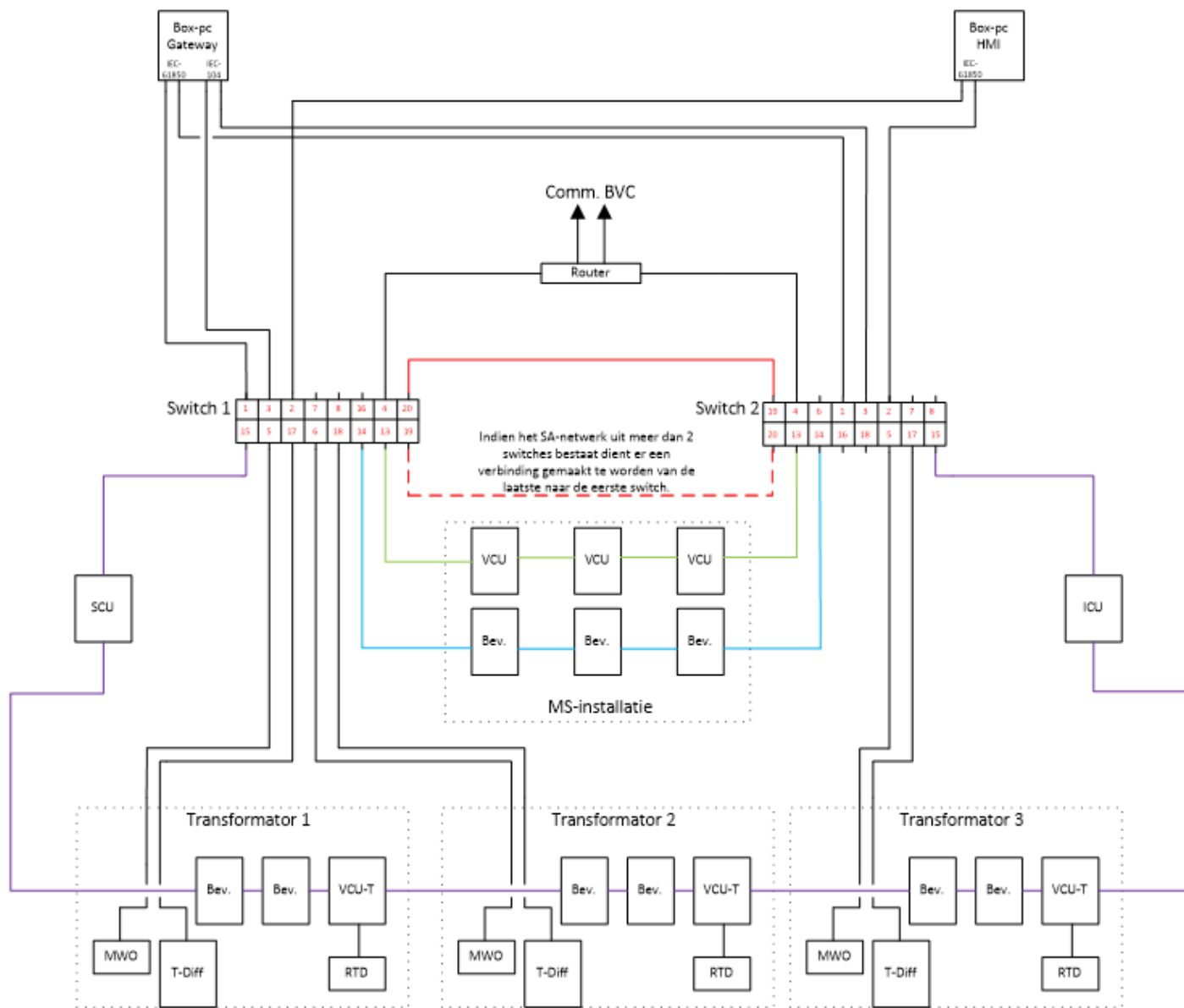

Voorbeeld netwerkoverzicht



Veld controle unit (VCU)



Beveiligingsrelais